

heatmiser®

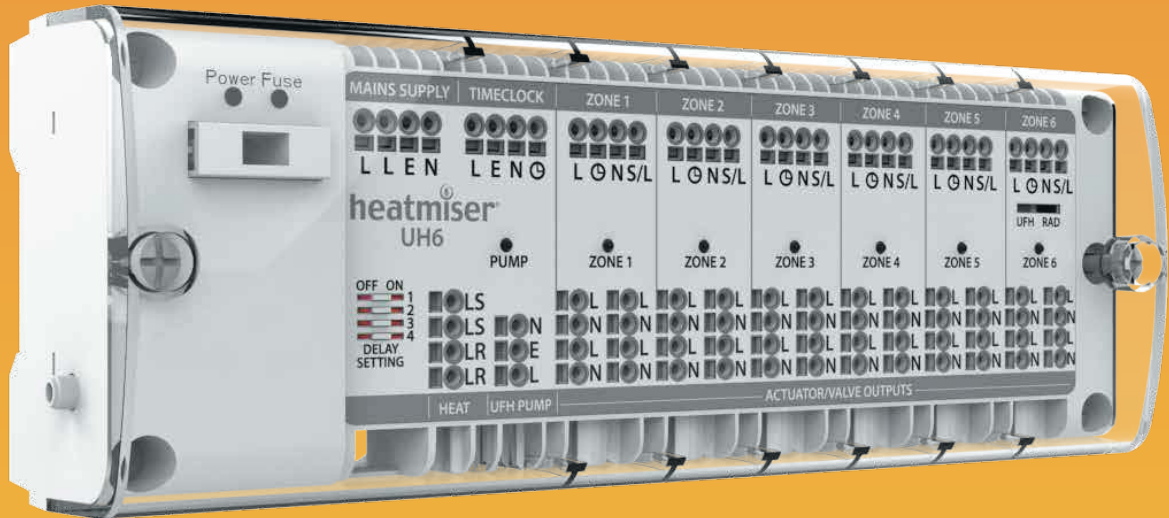

Model: UH6
Compact Wiring Centre

UH6 – Installation Manual

Description

The UH6 is an 6 Zone wiring centre for use with Heatmiser 230v powered thermostats.

The UH6 can be used to control any actuator or valve which requires a 230v AC signal to open. For mid position valves and those requiring a closing signal, a changeover relay would be required.

At the same time, the UH6 offers the ability to operate a boiler or other heat source through a volt free output.

A manifold pump output designed for use with underfloor heating systems, is also included as standard.

When zones 1-5 are being used for underfloor heating zones, zone 6 can be used as an isolated radiator zone by using the UFH/RAD switch.

Switch set to RAD;

When zone 6 calls for heat this will provide an output to a radiator zone valve from the 4 x 230v L & N zone outputs, but WILL NOT enable the Heat or UFH Pump outputs.

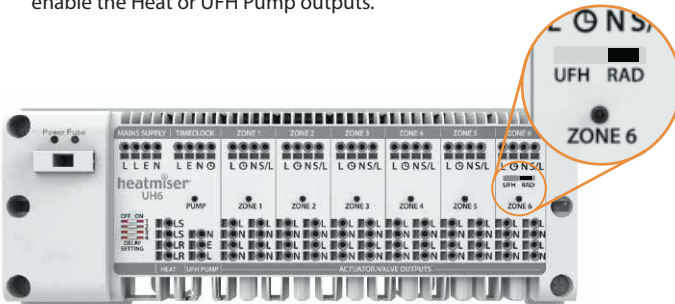

Switch set to UFH;

When Zone 6 calls for heat, this will act as an underfloor heating zone, by enabling the 4 x actuator, Heat and UFH pump outputs.

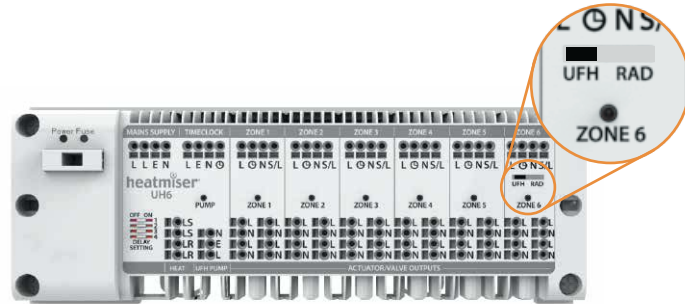

Removing Cover & Din Rail Installation

To remove the clear front cover of the UH6, turn the two screws 90° counter clockwise and pull the cover off.



The UH6 can be mounted directly to the wall using the two screw holes in the back, or alternatively, the unit can be DIN rail mounted, as shown here;

Din Rail Mounting

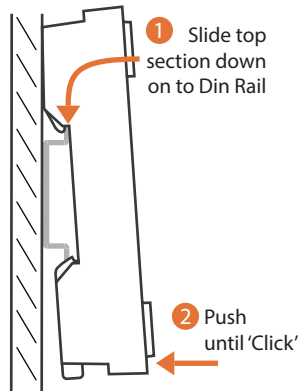
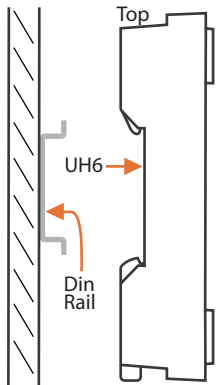

Removing from Din Rail

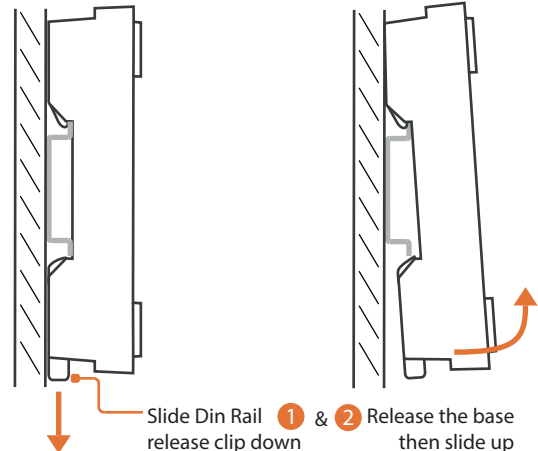

UH6 Explained

Fuse

5 Amp, 20mm anti-surge fuse.
This fuse supplies power to all 230v outputs from the UH6. The fuse also protects the zone & pump outputs. When the fuse is blown, the Fuse LED will light Red. To replace the fuse, remove the fuse holder, replace fuse & re-insert fuse holder.

Mains Supply

Power supply into the UH6 which should be fused at 5 amps these connections are marked
L = Live or phase 230v AC 50/60Hz
E = Earth
N = Neutral
When powered on, the power light will be green.

Delay Setting Switches

Heat & UFH Pump delay

When there's a demand it is possible to set a timed delay, before activating the Pump & Heat* outputs.

1 Minute

1 = On, 2 = Off

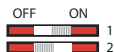

2 Minutes

1 = Off, 2 = On

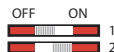

3 Minutes

1 = On, 2 = On

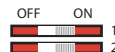

Creepage Function

During hot weather the heating may not be required as often, which means after long periods of the UFH pump not being used, the pump can seize and refuse to operate.

To prevent this, it is good practice to operate the pump once a day, the creepage function does this for you. Once enabled the UH6 will operate the pump for 1 minute, only if the outputs have not been operated by a thermostat, within the preceding 24 hours.

This function does not operate the HEAT output.

Enabled

3 = On



Disabled

3 = Off



*Heat Output Delay

This determines if the HEAT output is affected by the delay configured on switches 1 & 2.

Delay On

4 = On



Delay Off

4 = Off

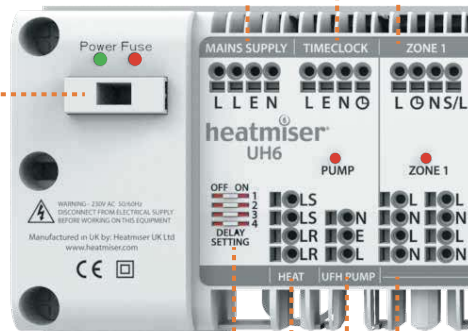

Heat

This is the main call for heat for the system, there are 4 connections;

LS = Live Supply

LS = Live Supply

LR = Live Return

LR = Live Return

Electrically this is a volt free switch, The supply placed on the LS connection, is fed to the LR connection when there is a call for heat.

Time Clock Input

L = Live supply
E = Earth
N = Neutral supply
⊖ = Switch live input from time clock, this enables the ⊖ terminal on the thermostat connections.

Zones 1...6 (Inputs)

Zone inputs are clearly marked at the top of the circuit board;
L = Live supply to thermostat.
⊖ = Timed switch live to thermostat, activated by the ⊖ input from the time clock.
N = Neutral supply to thermostat.
S/L = 230v switch live from thermostat, this activates the corresponding zone output.

UFH/RAD (Zone 6)

This switch determines if zone 6 activates the HEAT & UFH Pump terminals as well as the actuator/valve output, when there's a demand.

UFH Zone

HEAT & UFH Pump Enabled



Radiator Zone

HEAT & UFH Pump NOT Enabled

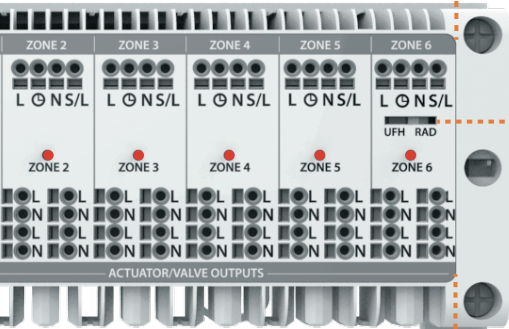

Zones 1...6 (Actuator/Valve Outputs)

Zones outputs are clearly marked
L = Live out to actuator or valve
N = Neutral to actuator or valve
There are four live (L) connections and four neutral (N) connections.
The L & N connections correspond to the thermostat zone wired in at the top of the UH6.
When there's a demand from this zone, all four sets of L & N connections are activated, the corresponding zone LED will light up.

UFH Pump

This output is used for an underfloor heating manifold pump.

Connections are clearly marked;

N = Neutral

E = Earth

L = Live

When an under-floor heating zone sends a call for heat to the UH6, the live & neutral output will supply 230v to the manifold pump. It is recommended that this is fed through a high limit switch placed on the heating manifold, to protect against mechanical failure of the manifolds temperature control.

UH6 Wiring

Cable sizes that can be used: **Stranded cable** 0.75mm - 1.5mm. **Solid core cable** 1.0mm - 1.5mm

Cable lengths for zone inputs should be measured according to the diagram shown below.

The L, ⊕, N & S/L cables are the same length for all zones as shown in the diagram on the left.

The length of the earth cable will differ depending on the zone number being wired.

The cable size example on the left shows the longest earth cable length from zone 6 on the far right, to the earth connection block on the far left.

Below shows an example of how the earth wire on each cable* should connect to the earth connection block.

*The Time Clock input does not need to be connected to the earth connection block.

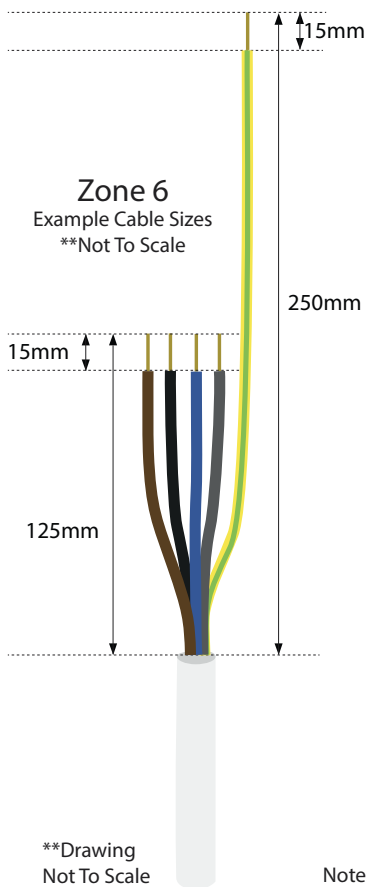

**Drawing
Not To Scale

Earth Connections

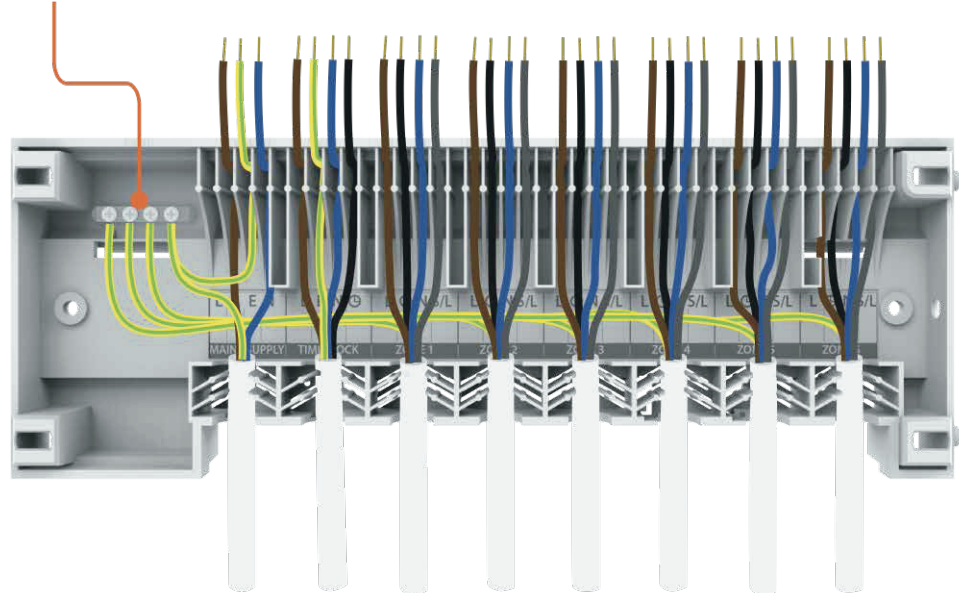

Note: Cable colours may vary depending on manufacturer or country.

Connecting Mains Supply

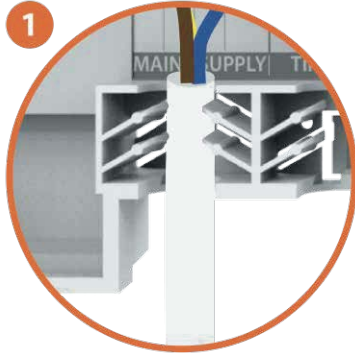

1 Clamp the insulated part of the cable in the cable grips.

Position the mains supply L (Live) cable in the L slot.
Position the mains supply Neutral cable in the N slot.
Push into the groove to hold cable in position.

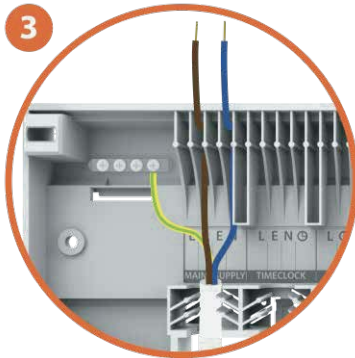
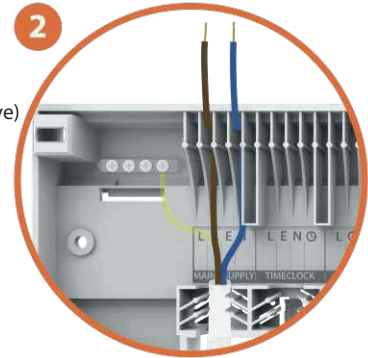

3 Connect the earth cable from the mains supply into the first earth connection on the UH6 earth terminal block.

Using approx 170mm length of earth cable, link from the first earth connection on the UH6 earth terminal block, and position in the mains supply E (earth) slot, as shown here. Push into the groove to hold cable in position.

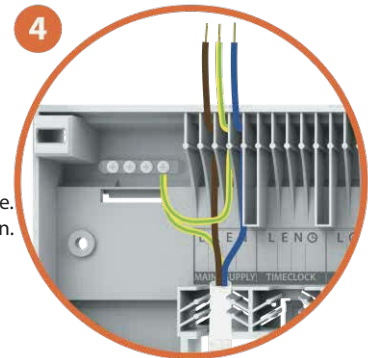

Timeclock & Zone Connections

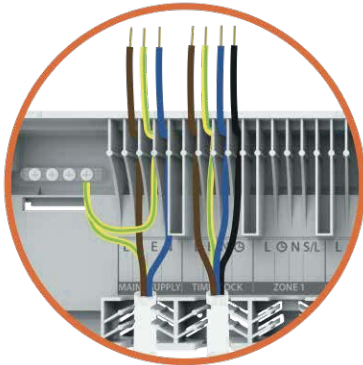

When using non programmable thermostats, connect the Time Clock cable as shown here. The earth cable from the time clock goes directly in the earth slot.

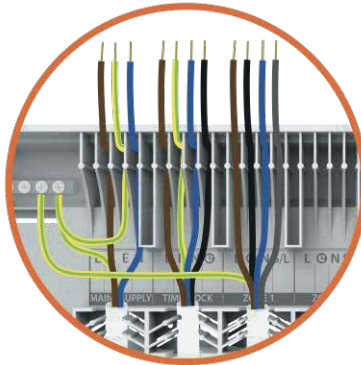

Wire the thermostat connections as shown here, connect the earth from the thermostat to the earth connection block on the left, repeating for additional zones.

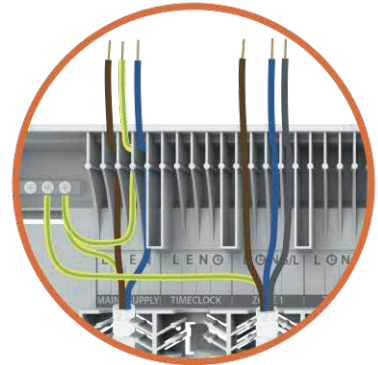

This example shows wiring for programmable thermostats that do not require a master time clock on the system.

Note: The \ominus connection is not used. Repeat for additional zones.

A complete wiring example of the UH6 is shown on page 5

Installing UH6 Front Module

Locate the UH6 front module on to the back plate, ensuring each cable aligns with the slots on the front panel.
Turn the four screws 90° clockwise to lock the front module in position.

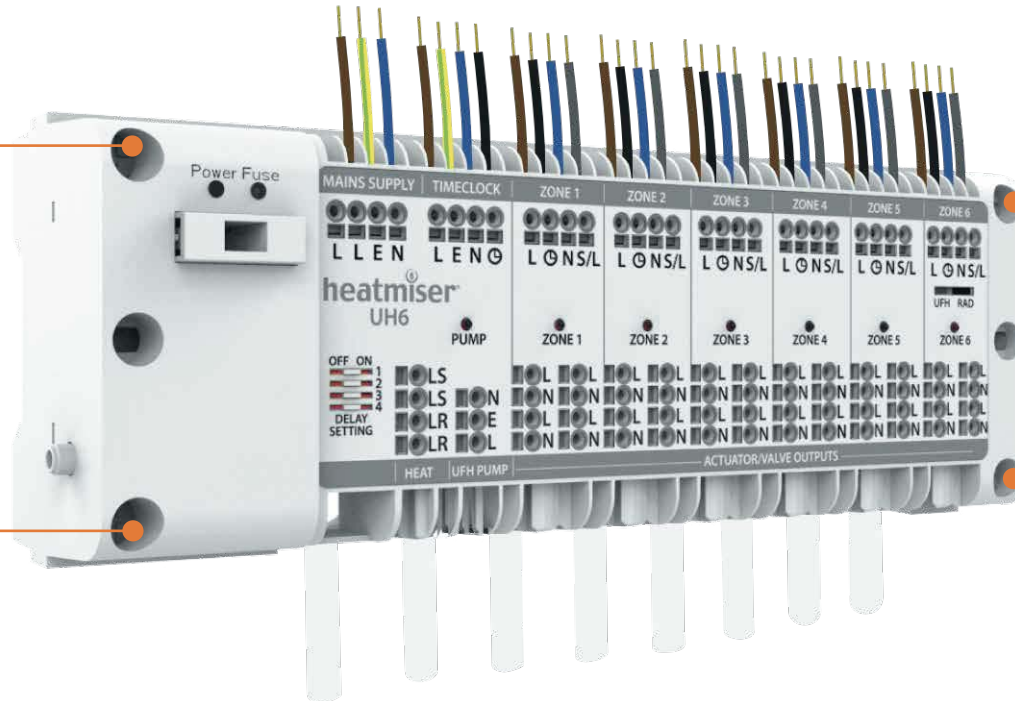

Inserting Thermostat Cables

Once the front module has been locked in position, the next step is to bend each cable around and insert into the cable clamp. As shown here.

For stranded cables, it may be necessary to twist the cable strands & open the cable clamp before inserting the cable.

To open the cable clamp, insert a small screwdriver into the slot underneath the cable entry, and push on the spring loaded button, the cable entry will open wider to allow you to insert the cable.

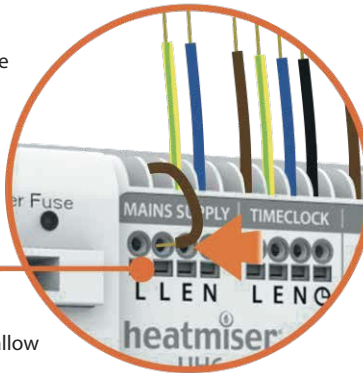

You may have a preference of inserting the cables from right to left or left to right. Once you've finished inserting your thermostat cables, the UH6 will appear similar to as shown below...

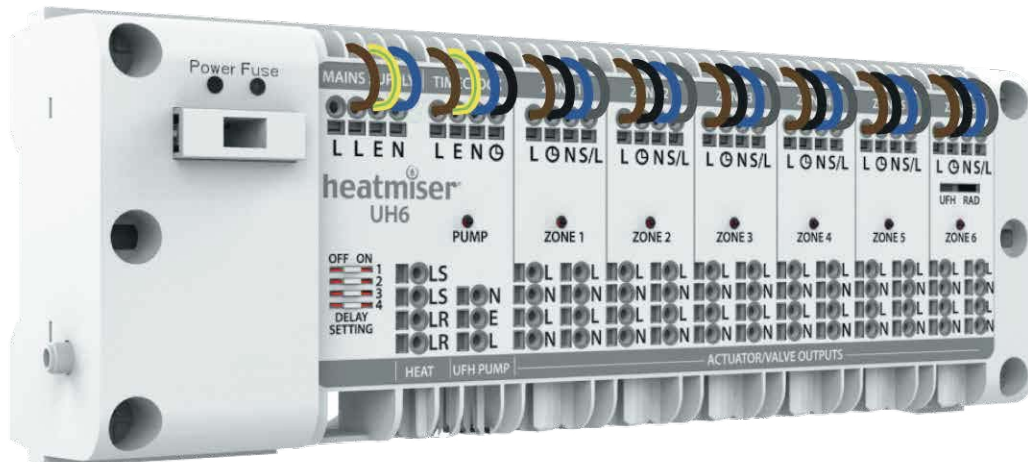

Inserting Actuator Cables

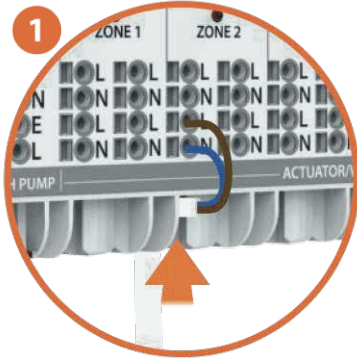

Each zone output has connections for up to 4 x 230v actuators.

1st Actuator: Use the lower left side L & N connections. Clamp the insulated part of the actuator cable in the cable grips by pushing upwards. Bend the actuator wires around & insert the Neutral wire into the lower N connection. Then insert the Live wire into the lower L connection. As shown in image 1.

2nd Actuator: Use the lower right side L & N connections. Clamp the insulated part of the cable in the cable grips by pushing upwards. Bend the actuator wires around & insert the Neutral wire into the lower N connection. Then insert the Live wire into the lower L connection. As shown in image 2.

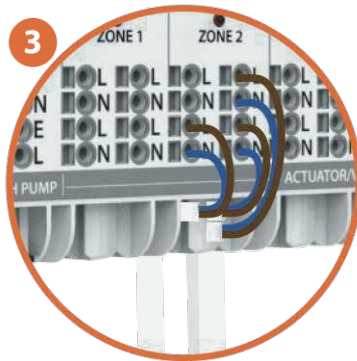

3rd Actuator: Use the upper right side L & N connections. Clamp the insulated part of the cable in the cable grips by pushing upwards. Bend the actuator wires around & insert the Neutral wire into the upper N connection. Then insert the Live wire into the upper L connection. As shown in image 3.

4th Actuator: Use the upper left side L & N connections. Clamp the insulated part of the cable in the cable grips by pushing upwards. Bend the actuator wires around & insert the Neutral wire into the upper N connection. Then insert the Live wire into the upper L connection. As shown in image 4.

Repeat this process for all other zones, any outputs that are not needed can be ignored.

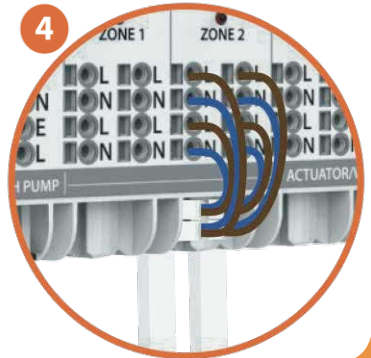
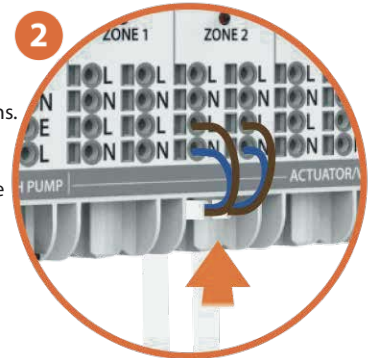

Inserting UFH Pump & Heat Output Cables

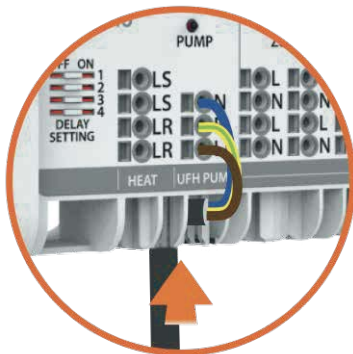

UFH Pump: This 230v output is used for an underfloor heating manifold pump.

Connections are marked;

N = Neutral

E = Earth

L = Live

When a zone calls for heat*, the live & neutral output will supply 230v to the manifold pump. It is recommended that this is fed through a high limit switch placed on the heating manifold, to protect against mechanical failure of the manifolds temperature control.

Clamp the insulated part of the cable in the cable grips by pushing upwards.

Bend the pump wires around & first insert the Live wire into the L connection.

Then insert the Earth wire into the E connection.

Next insert the Neutral wire into the N connection, as shown here.

Heat: This is the voltfree heat output for the system and should be wired to your heat source.

Connections are marked;

LS = Live Supply

LS = Live Supply

LR = Live Return

LR = Live Return

Electrically this is a volt free switch, whatever supply is placed on either of the LS connections, is fed to the LR connections when there is a call for heat*.

Clamp the insulated part of the cable in the cable grips by pushing upwards.

Bend the wires around & first insert the LR wire into the LR connection.

Then insert the LS wire into the LS connection, as shown here.

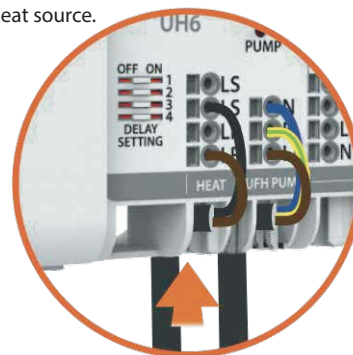

*The Heat & UFH Pump outputs are not activated for zone 6 when the switch is set to Rads, explained on page 1.

Fitting the front cover

To place the clear front cover on to the UH6, line up the front cover with the slots along the top & bottom edge, then slide the front on. Turn the two screws 90° clockwise to lock the front cover in position. The UH6 can now be powered up.

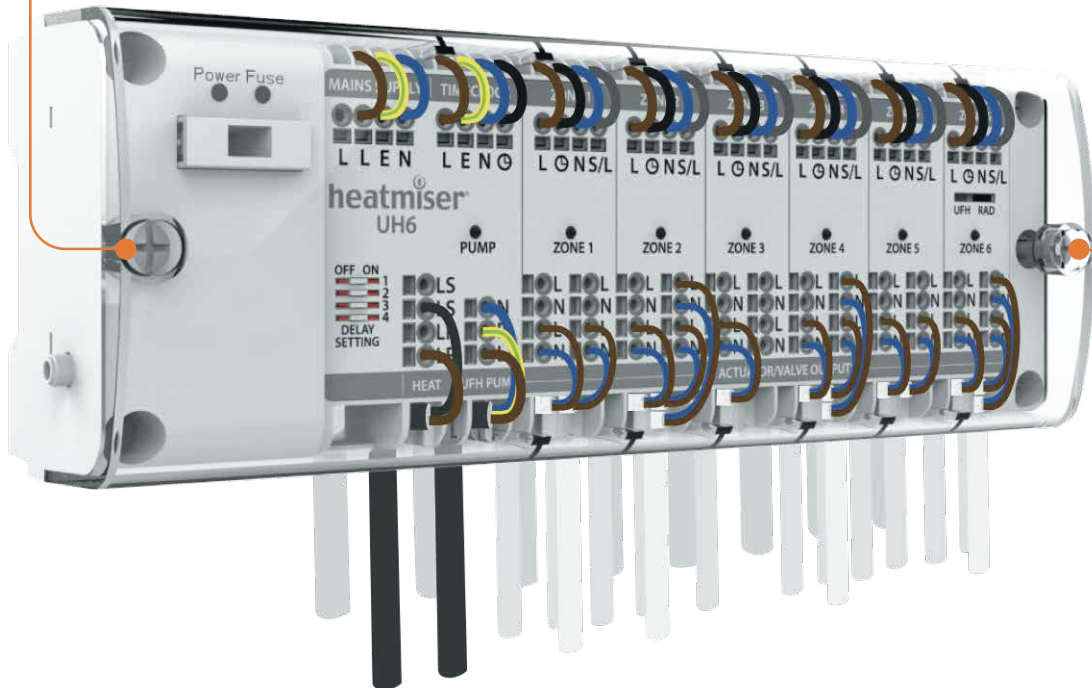

UH6 - DS-SB 6 ZONES WITH TIME CLOCK (5 X UFH, 1 X RADIATOR ZONE)

WIRING KEY

- NEUTRAL
- EARTH
- LIVE
- SWITCH LIVE
- TIMER LIVE
- END SWITCH
- or HEAT ENABLE

Slimline Timeclock

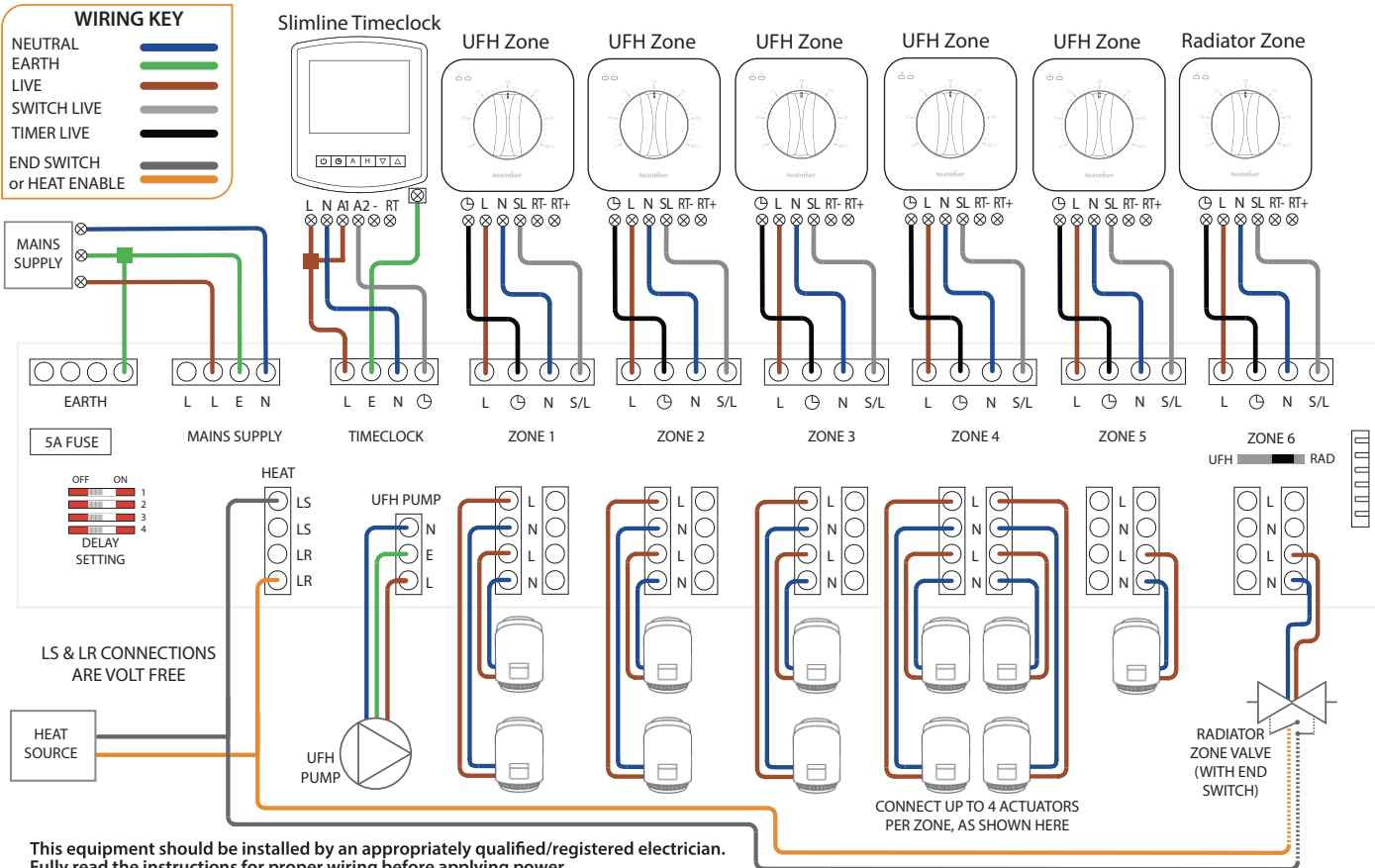

This equipment should be installed by an appropriately qualified/registered electrician. Fully read the instructions for proper wiring before applying power. The warranty does not cover damage from improper wiring or installation.

UH6 - NEOSTAT 6 ZONES (5 X UFH, 1 X RADIATOR ZONE)

WIRING KEY

- NEUTRAL
- EARTH
- LIVE
- SWITCH LIVE
- END SWITCH
- or HEAT ENABLE

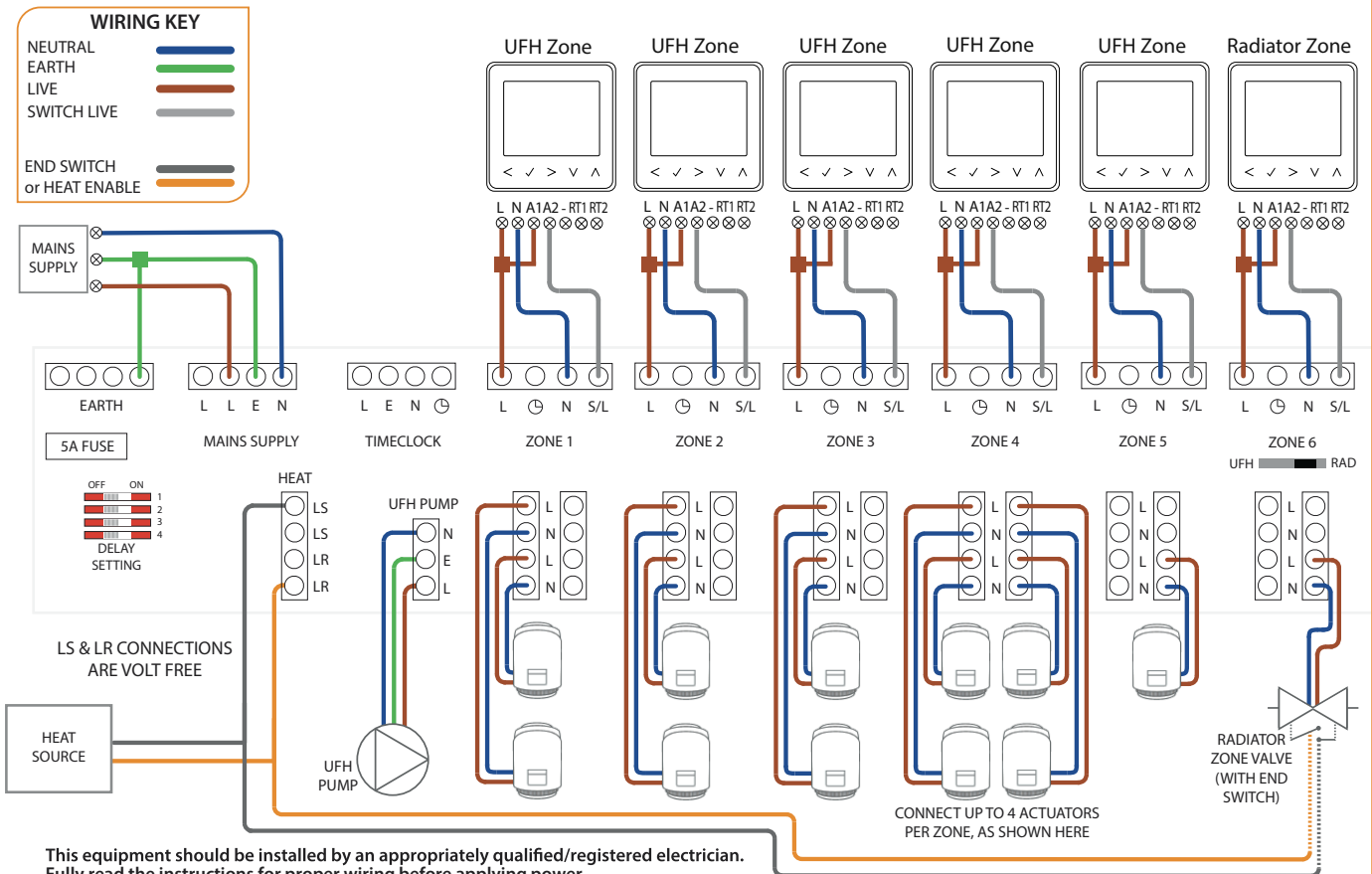

LS & LR CONNECTIONS ARE VOLT FREE

CONNECT UP TO 4 ACTUATORS PER ZONE, AS SHOWN HERE

This equipment should be installed by an appropriately qualified/registered electrician. Fully read the instructions for proper wiring before applying power. The warranty does not cover damage from improper wiring or installation.

UH6 - 230v Thermostat Range

WIRING KEY

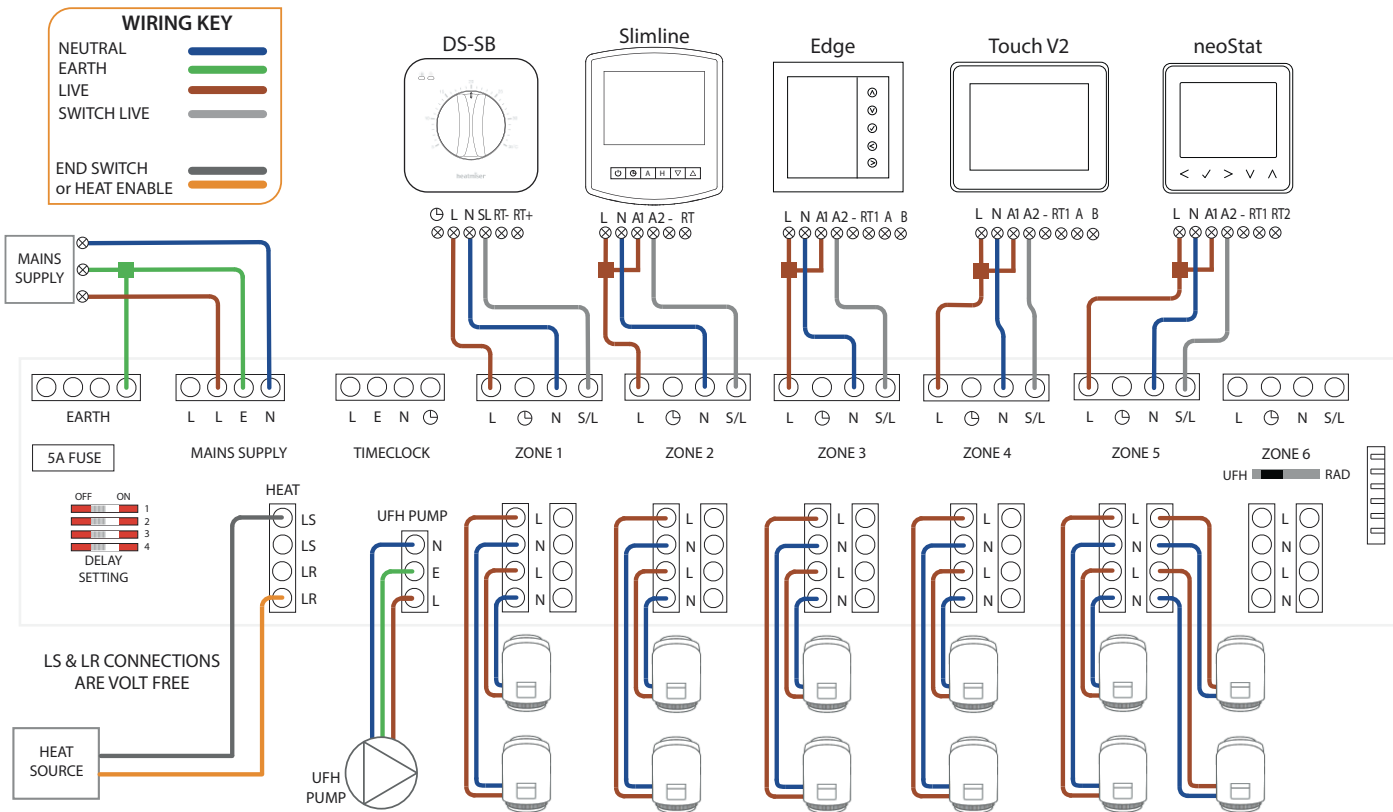
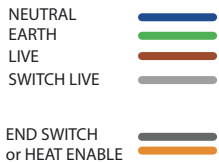

CONNECT UP TO 4 ACTUATORS PER ZONE, AS SHOWN HERE

This equipment should be installed by an appropriately qualified/registered electrician. Fully read the instructions for proper wiring before applying power. The warranty does not cover damage from improper wiring or installation.

System Configuration

ENGINEER TO COMPLETE ON INSTALLATION

UH6 Wiring Centre Title:

Title	Zone Type	
	Under-Floor Heating	Radiator
Zone 1	<input type="checkbox"/>	<input type="checkbox"/>
Zone 2	<input type="checkbox"/>	<input type="checkbox"/>
Zone 3	<input type="checkbox"/>	<input type="checkbox"/>
Zone 4	<input type="checkbox"/>	<input type="checkbox"/>
Zone 5	<input type="checkbox"/>	<input type="checkbox"/>
Zone 6	<input type="checkbox"/>	<input type="checkbox"/>



Notes

A series of horizontal dotted lines for writing notes, spanning the width of the page.



Notes

A series of horizontal dotted lines spanning the width of the page, intended for taking notes.



Want More Information?

Call our support team on: +44 (0)1254 669090

Or view technical specifications directly on our website:

www.heatmiser.com



PDF



FAQ



VIDEO



Follow us on:
twitter

Twitter: @heatmiseruk



Find us on:
facebook

Facebook: facebook.com/thermostats

Heatmiser UK Ltd

Units 1-5 Hurstwood Court, Mercer Way
Shadsworth Business Park, Blackburn,
Lancashire, BB1 2QU, United Kingdom.

Products Commonly used with the UH6 wiring centre.



Slimline v3



DS-SB v3



Touch v2



Edge



NeoStat v2