

**USE IN CONJUNCTION WITH YOUR MAIN THERMASKIRT® INSTALLATION INSTRUCTIONS**

**IMPORTANT:** Unless the ThermaSkirt® has been supplied factory cut, it is **ESSENTIAL** that the skirting is deburred. 10 revolutions of the ThermaSkirt® de-burrer or similar de-burring tool is recommended. A 'Bell Mouth' chamfer of (approx.) 2mm x 2mm is best to enable ease of installation of connectors. Any swarf or chippings **MUST** be removed before inserting any fittings into the skirting's feed and return channels. Otherwise your **WARRANTY MAY BE INVALID!** (See main installation instructions for full details. To download, go to [www.discreteheat.co.uk/technical.htm](http://www.discreteheat.co.uk/technical.htm)).

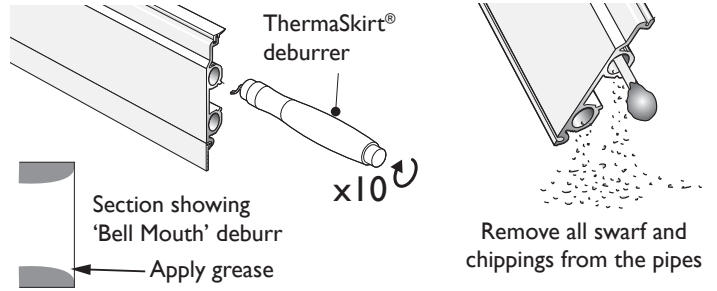

**INTERNAL CORNER KIT**



For each and every internal corner, a 60mm allowance overall is made for the connectors i.e. between 2 internal corners ( $I = L - 60\text{mm}$ ).

**CLOCKWISE INSTALLATION** - Insert the long leg of the connector into the first section before fitting the ThermaSkirt® to the wall mounting (A).

USE THE SILICON GREASE PROVIDED!

With a connector clip fully inserted into the next section, push it onto the mounting channel up to the first click. Next, slide it over the short legs of the connectors, ensuring both 'O' rings are covered and that the clip is fully engaged with the lugs on the connectors (B).

Push the ThermaSkirt® into position on the mounting channel so that it locates on the 'second click'.

Repeat each corner in a **clockwise** direction. On each internal corner you should end up with an unequal gap (approx. 40mm on the first piece and 20mm on the second) (C).

**TOP TIP:** For maximum security or should you forget the connector clip, DiscreteHeat recommends fixing the skirting with a single stainless steel countersunk screw (D). **Care must be taken not to drill through the two water channels on the ThermaSkirt®.**

Fix each corner cover in position by hooking over the top of each side of skirting, then pushing the bottom inwards until it clicks (E). Trim the cable cover and caulking gasket 5mm longer than required. These may then be tucked behind the corner covers and end covers to achieve a neat finish. Special internal corner covers may be required in some installations. Download a template from: [www.discreteheat.co.uk/technical/html](http://www.discreteheat.co.uk/technical/html)

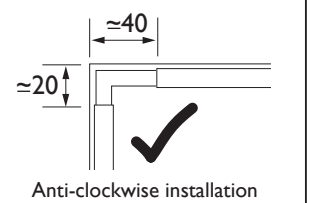
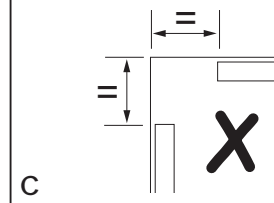
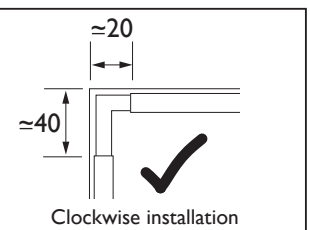
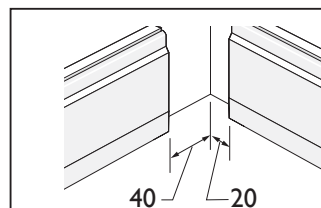
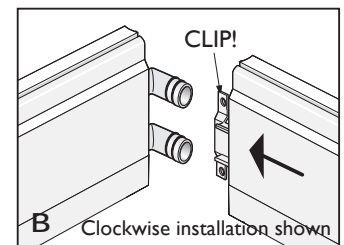
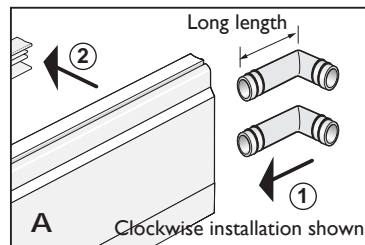
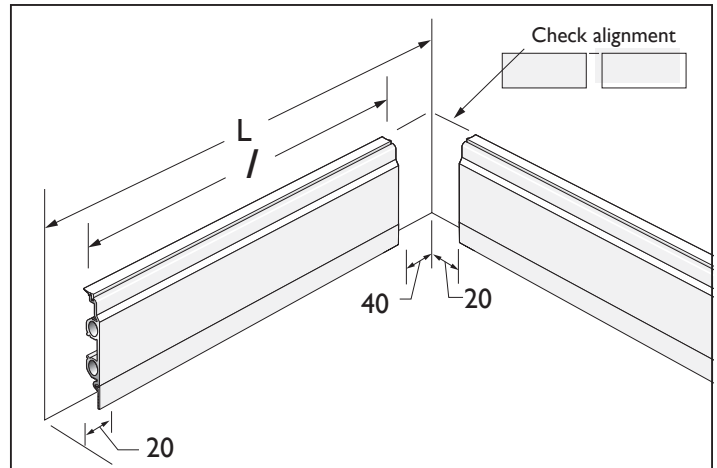

Completed corner with cover removed

